

Montagevarianten (PLISSEE)

Montage in der Glasleiste

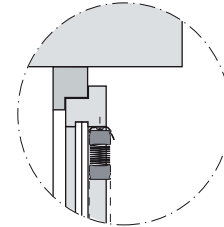
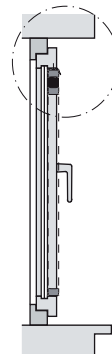
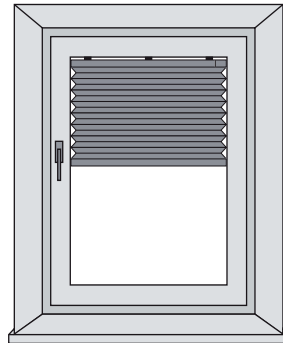
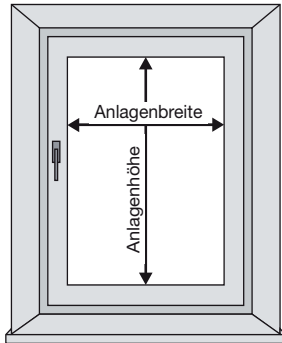

Hinweis:
Mindestglasleiste
= 25 mm

Empfehlung: Kleinstes gemessenes Maß abzüglich 2 mm pro Seite = Bestellmaß

Montage auf dem Fensterflügel

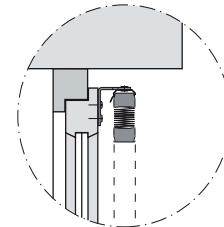
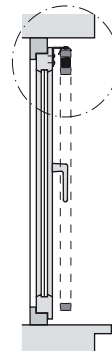
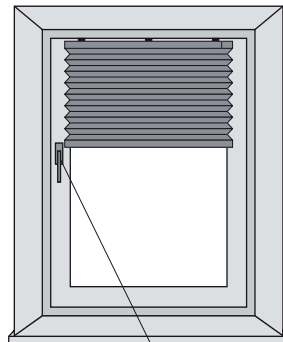
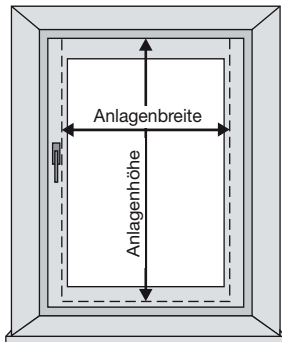

Hinweis:
Auf vorstehende
Beschläge achten
(Fenstergriff od. ähnl.)

Empfehlung: Seitlicher Überstand pro Seite ca. 20 mm (auf Beschläge achten)

Montage in der Fensternische

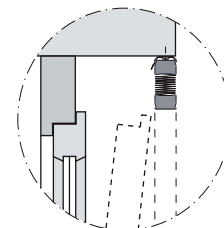
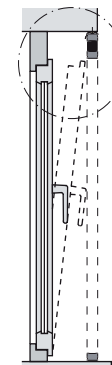
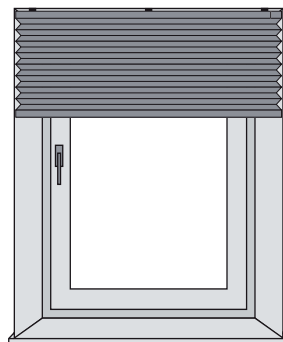
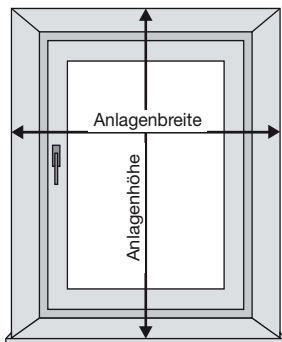

Hinweis:
Pakethöhe beachten,
wegen Fensteröffnung

Empfehlung: Kleinstes gemessenes Maß abzüglich 2 mm pro Seite = Bestellmaß

Montage vor der Fensternische

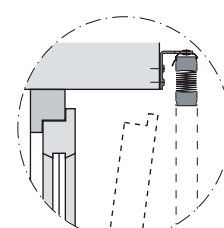
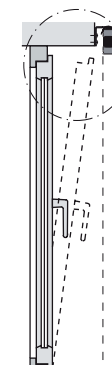
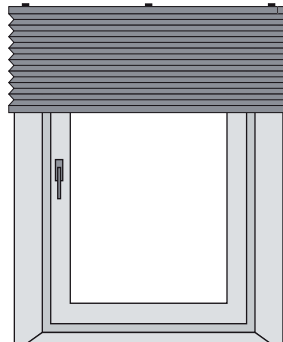
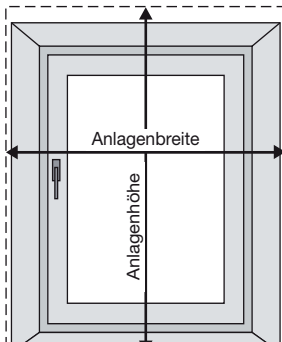

Hinweis:
Auf Montageposition
achten, wegen
Fensteröffnung

Empfehlung: Seitlicher Überstand pro Seite ca. 50 mm

Deckenmontage

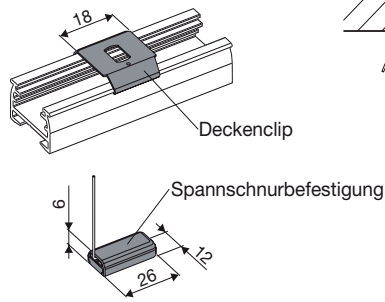

Standardprofil mit Deckenclip, 20 mm

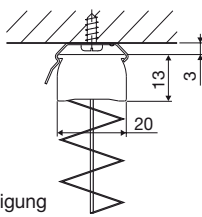

Motor-/Kettenzugprofil mit Deckenclip, 27 mm

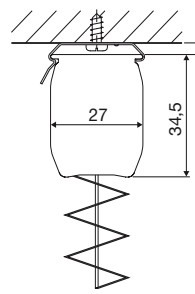

Pendelsicherung mit Spannschnurbefestigung

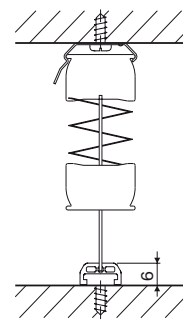

Wandmontage

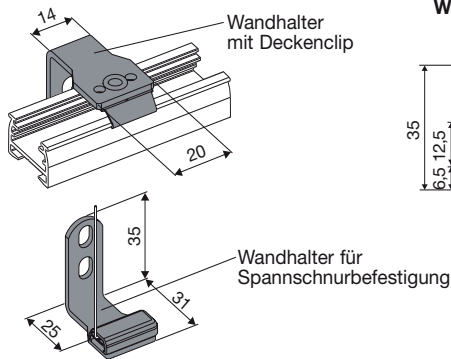

Standardprofil mit Wandhalter + Deckenclip

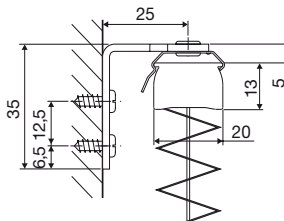

Gespannte Anlage mit Wandhalterbefestigung

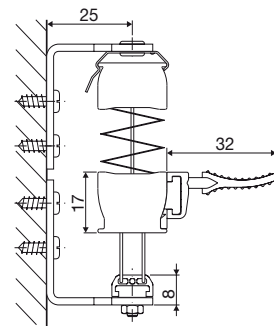

Wandmontage

(mit verstellbarem Wandhalter)

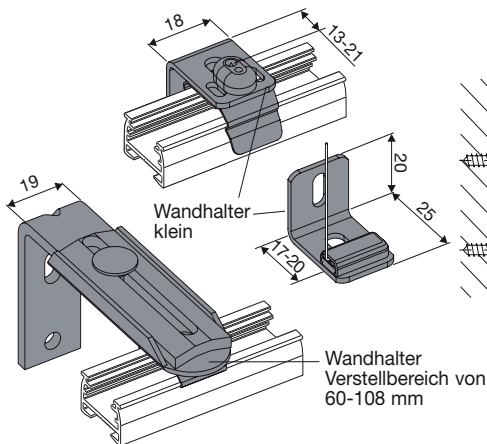

Standardprofil mit Wandhalter, 60-108 mm

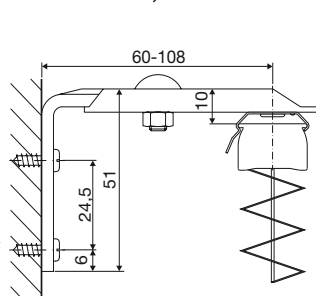

Standardprofil mit Wandhalter, klein

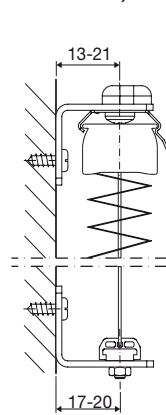

Fensterflügelmontage

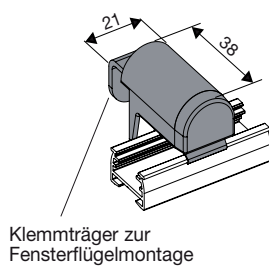

Standardprofil mit Klemmträger + Deckenclip

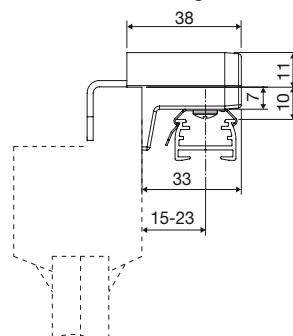

Seilbefestigung mit Klemmträger

